

BL 2.4/12-11

Specifications

Part Number	B110112	HH'	20.43mm
Focal Length	12.0mm	Mount	C-Mount
Image Circle	11mm	MaxD	Φ33.50
Max. F#	F2	Filter	M28×0.5
Magnification	0.0 - 0.25	Σd	47.6mm
Spectrum	420nm - 680nm	A'	4.3mm - 7mm
Working Distance	50mm - ∞	A'f	14.87mm - 17.57mm
Resolution	3.45 μm		

Mechanical Drawing

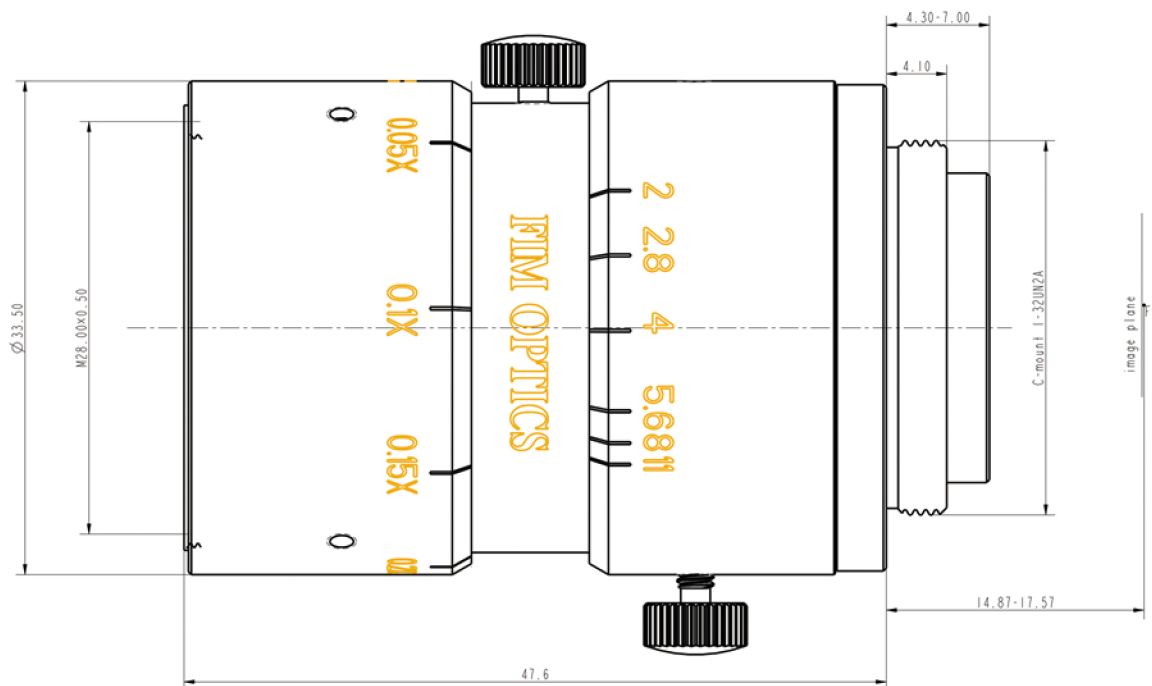

Distortion

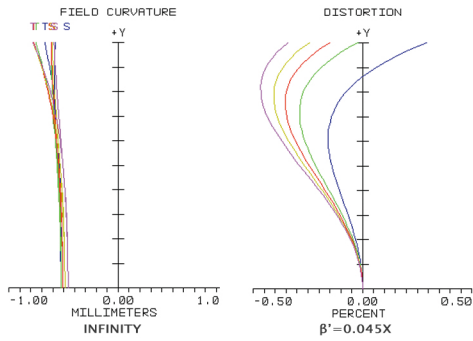

Field Curvature

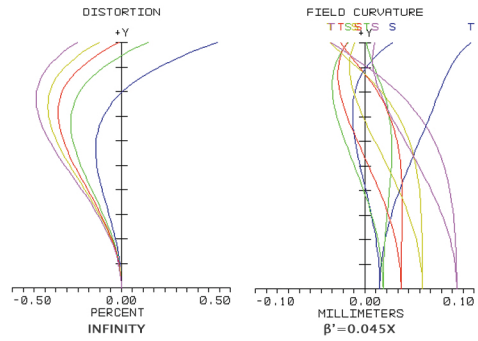

Modulation to Relative Image Height

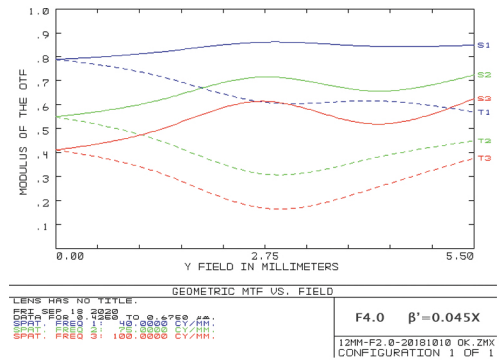
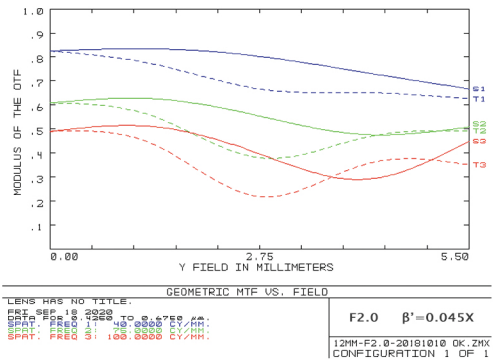

Relative Illumination

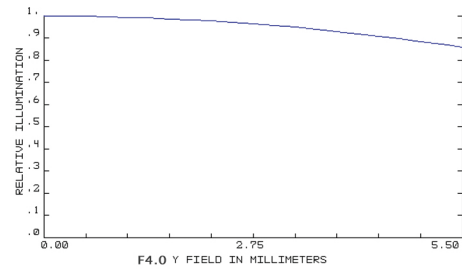
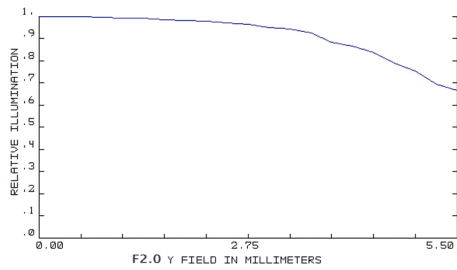

Transmittance

